

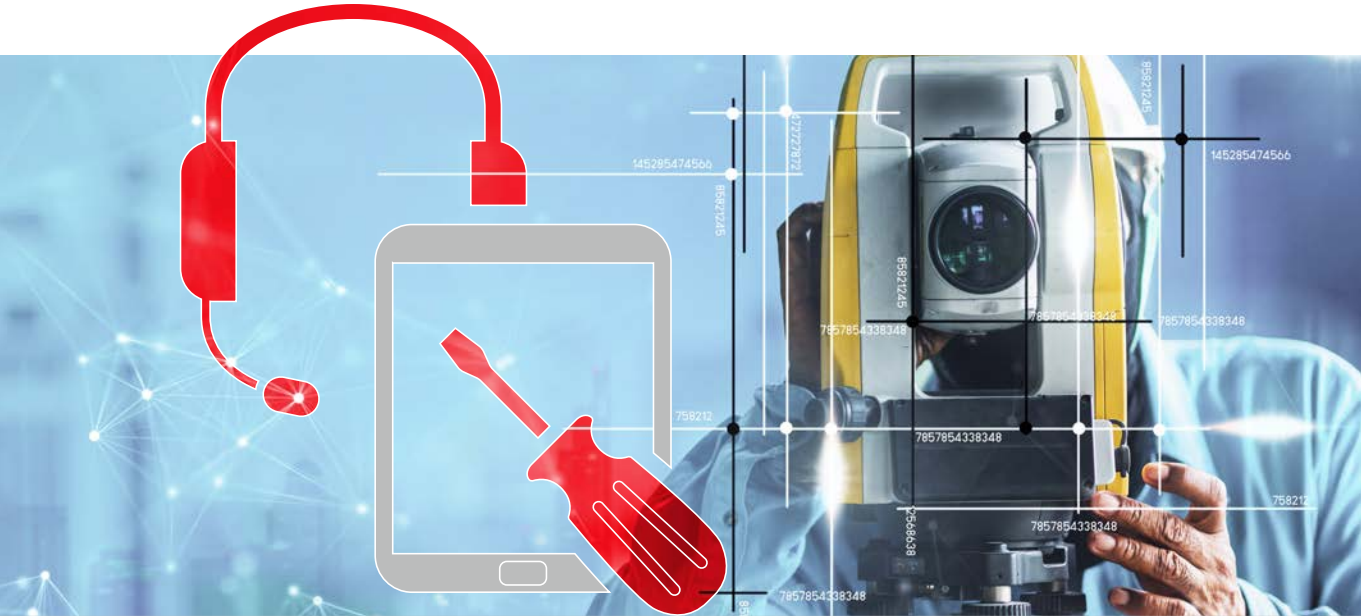

# MEASUREMENTS ON KILNS AND DRUMS



>>

>>>

>>

**WE LIVE SERVICE** – ADDED LIFETIME AND ADDED VALUE

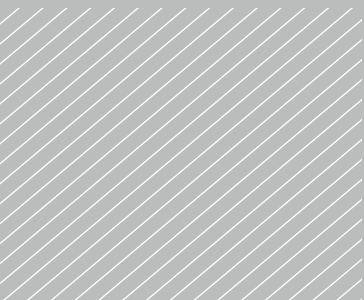

# GRENZEBACH PRESERVES THE VALUE OF YOUR EQUIPMENT

## PREVENTIVE KILN AND DRUM SURVEY AND ANALYSIS

# WE SERVICE

# PRECISION MINIMIZED RISK LONG LIFESPAN

With the Grenzebach measuring and analysis services

Our service professionals recommend preventive maintenance to ensure trouble-free operation of your equipment and preserve its value. Preventive inspections detect damage at an early stage and help to minimize downtimes and repair costs.

Grenzebach uses comprehensive measuring and analysis techniques to assess the condition of your rotary kilns, drums, dryers, coolers, sectional and multi-tube coolers and calciners. The specialized equipment used by our highly trained engineers allows us to carry out the measurements during both hot operation and shutdown periods. We present our findings to you right away on site and will gladly advise you on further preventive maintenance planning. If anomalies are detected early on, remedial action can be taken in an easy and cost-effective way and plant downtimes be avoided.

### Benefits at a glance:

- ✓ Measurements during operation
- ✓ Early identification of misalignment/deformations
- ✓ Expert interpretation and analysis of the measurements
- ✓ Improved maintenance planning
- ✓ Comprehensive documentation



# GRENZBACH SURVEY AND ANALYSIS SERVICES AT A GLANCE

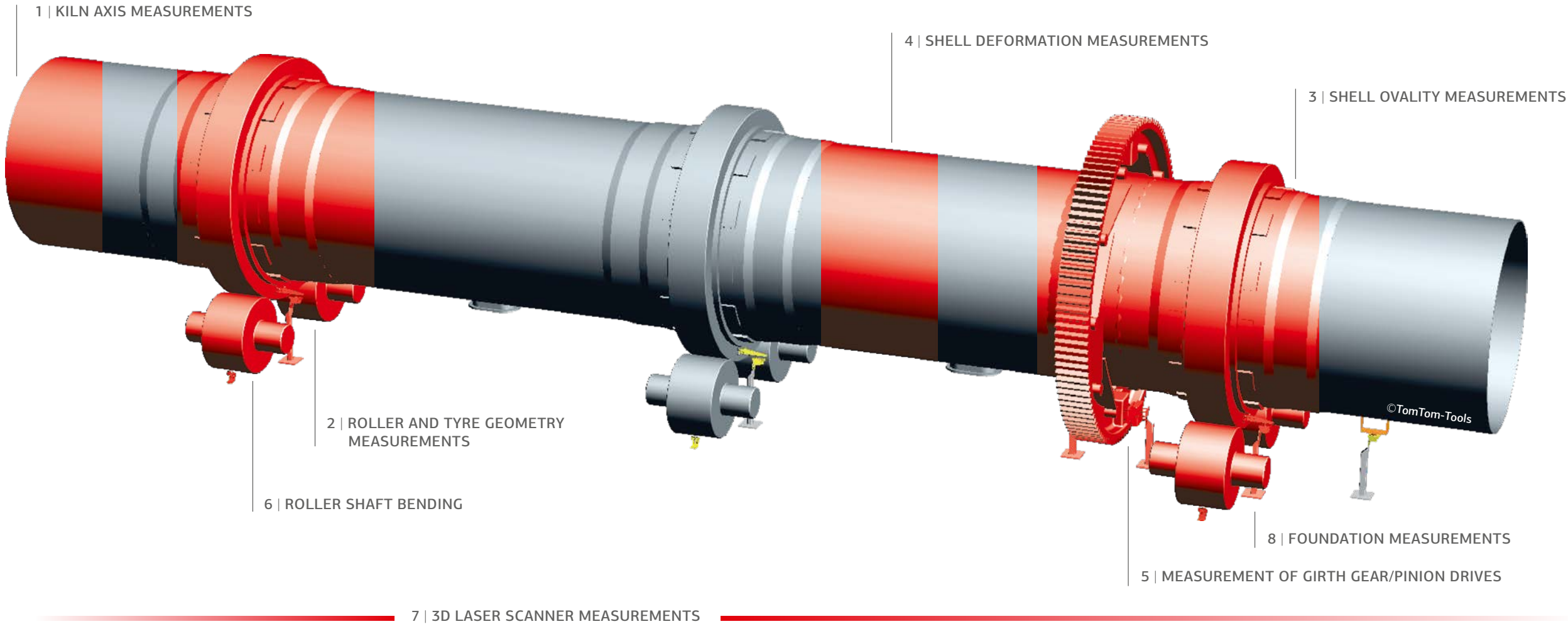

## 1 | KILN AXIS MEASUREMENTS

The kiln axis measurement serves to quickly identify horizontal and vertical deviations in the gradient of the kiln axis. Misalignment means higher mechanical stress and an increased risk of cracks developing. Identifying anomalies at an early stage and making the necessary corrections also helps to prevent damage to the kiln rollers. Grenzebach assists you with forward-looking maintenance planning in this context.

- » Quick and precise measurement of the kiln axis
- » Calculation of the axis and gradient deviation

✓ Definition and calculation of the necessary corrections

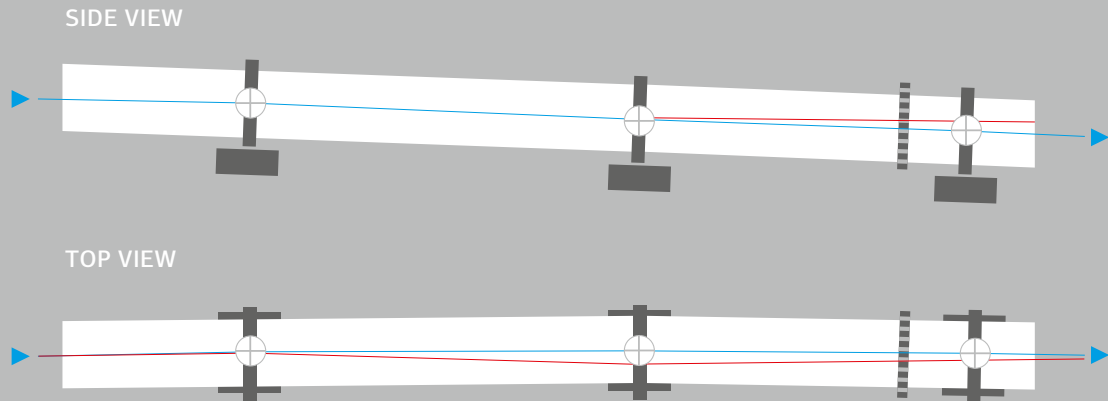

## 2 | ROLLER AND TYRE GEOMETRY MEASUREMENTS

An analysis of the roller and tyre geometry measurements identifies and locates existing misalignment and incorrect positions. The rollers and tyre diameters are measured across the full running face in order to detect any skew and incorrect angles between tyres and rollers. Our Service Department proposes suitable corrective action to improve the mechanical stability of your roller/tyre system geometry.

- » Determination of the roller offset
- » Measurement of the roller and tyre diameters across the entire running face
- » Calculation of angular deviations between tyre and rollers

✓ Early detection of incorrect positions

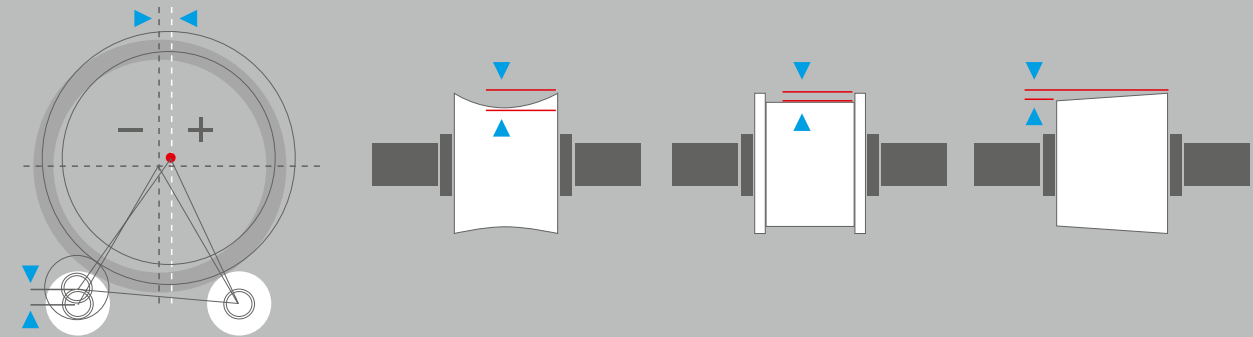



### 3 | SHELL OVALITY MEASUREMENTS

As part of the shell ovality measurement Grenzebach analyses the roundness of your kiln shell and precisely identifies existing deformations in the tyre areas. Based on the analysis, Grenzebach defines an action plan to extend the life of the refractory lining.

» Shell ovality measurements in the tyre areas

✓ **Extended life of the rotary kiln shell**

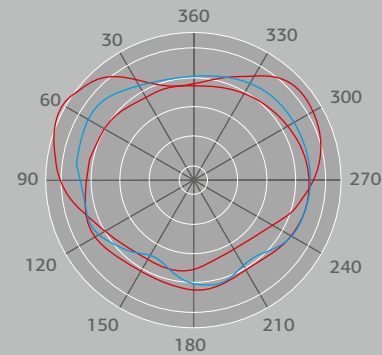
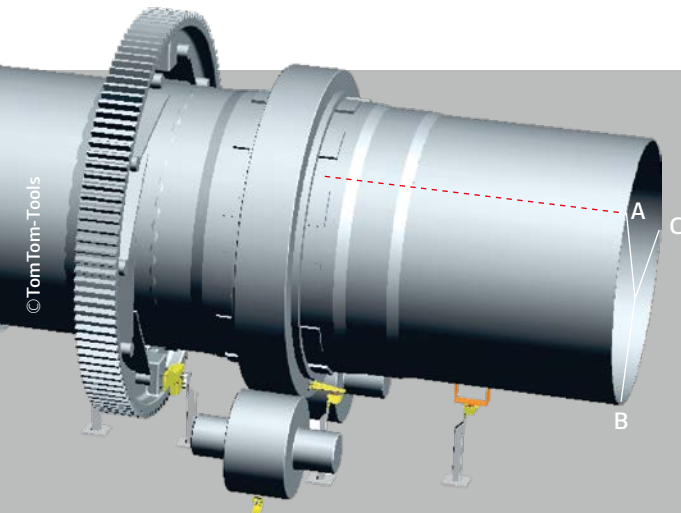

### 4 | SHELL DEFORMATION MEASUREMENTS

Kiln shell fatigue often causes cracks. Grenzebach can perform individual shell measurements to spot existing deformations of the kiln shell at an early stage. The precise measurements can cover specific sections and areas but also the complete shell. Benefit from a user-friendly 3D visualization of the findings. Grenzebach also provides you with specific advice on how to extend the service life of your rotary kiln shell.

» Individual survey of the kiln shell  
» Identification of kiln shell deformations

✓ **Extended life of the rotary kiln shell**

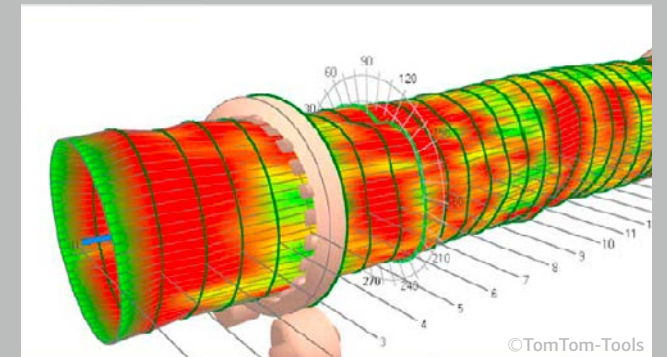
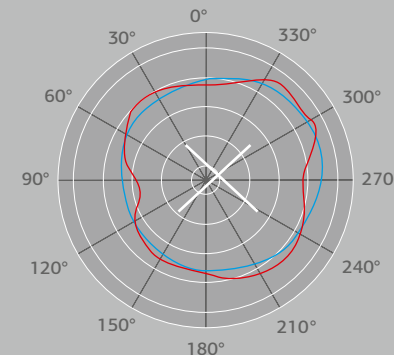

## 5 | MEASUREMENT OF GIRTH GEAR/PINION DRIVES

Our service specialists carry out comprehensive measurements to examine the clearance between girth gear and pinion and check the meshing of the teeth. Deviations in the gradient between girth gear and pinion are corrected under the maintenance management scheme, and corresponding actions/measures are planned.

- » Determination of the radial and axial girth gear runout
- » Check of the meshing between pinion and girth gear
- » Calculation of deviations in the gradient between girth gear and pinion

✓ Definition and calculation of the necessary corrections/measures

## 6 | ROLLER SHAFT BENDING

Our comprehensive range of analyses and measurements includes checks for anomalies in the roller shafts. The shafts are examined for unwanted deformations.

- » Identification of anomalies and irregularities

✓ Extended life of the rotary kiln shell

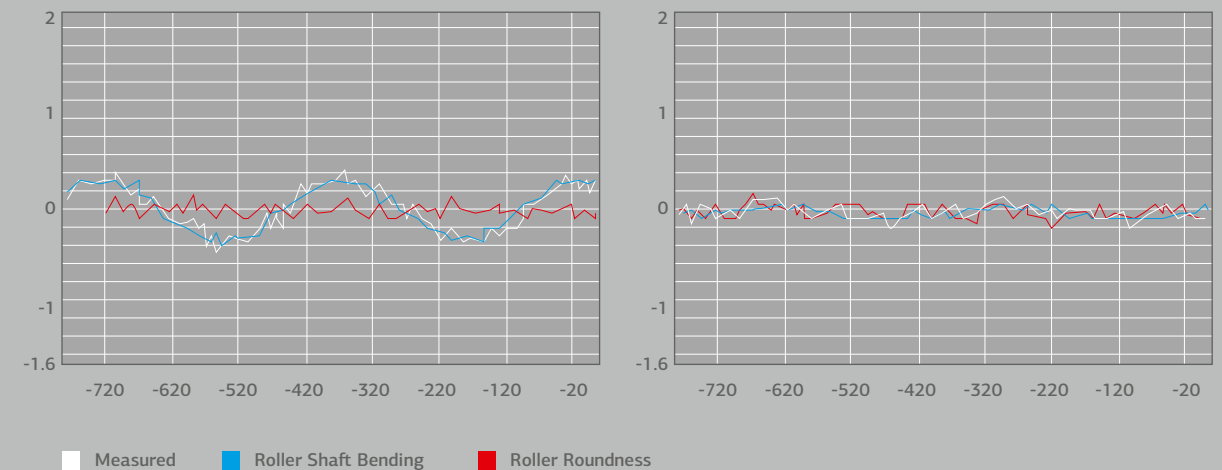
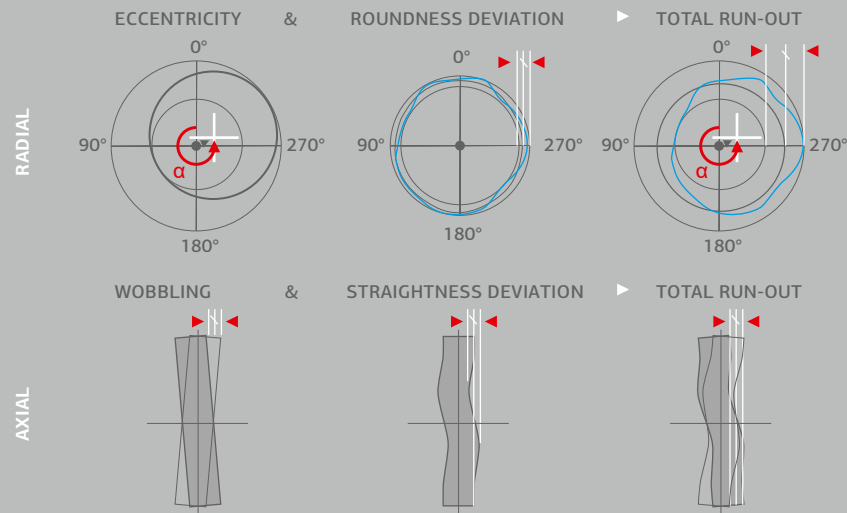

## 7 | 3D LASER SCANNER MEASUREMENTS



**You are planning rebuilds, modifications, replacements - but you don't have reliable spatial and geometrical data and need to obtain these first?**

Errors in surveying existing structures and spaces are mostly due to complex layouts, with surfaces, tubes, pipes, supports and other elements that do not meet at right angles. Measuring over large distances or detecting interfering contours at heights usually proves difficult as well. With no laser scanner available, sketches with approximate dimensions and large measuring tolerances are made. Inaccurate and additional measurements or costly mistakes in planning may be the consequence.

**With its 3D laser scanner, Grenzebach has the ideal tool for indoor and outdoor measurements**

Scans are carried out from different angles and perspectives and from various scanner locations. The scan data are then processed by a software and merged into a point cloud. The measurement includes all machinery, ducts, pipes etc. found in the surveyed space or room. This reduces the time needed for measuring by up to 80 %. Less time needed means substantially lower costs for you: All details - from individual components to complete plants- can be recorded within a very short time. There is no need for additional time-consuming and expensive measurements, so we can guarantee shortest downtimes of your production lines.

You can integrate the generated point cloud into existing systems and applications and benefit from it in a number of ways:

- To minimize risks and prevent industrial accidents in parts of the plant that are difficult to access
- To import and use the data in other CAD applications

### **Precise measurement**

The 3D laser scanner detects its surroundings in a radius of 60 to 120 m with an accuracy of a few millimetres. It takes account of all details that can never be recorded by hand with a folding rule, pencil, notepad or even a hand-held laser.

- » Fast, easy and precise measurements of objects, buildings, building facades and structures, production lines and utility installations
- » Integrated GPS receiver for measurements even in strong sunlight
- » Measurements with a mouse click on an office PC instead of on site
- » Collision checks in merged CAD data with Autodesk Navisworks (also in foreign formats from Pro E, Solid Works, etc.)
- » Documentation of the on-site progress via laser scan
- » Creation of 3D models of entire factory sites

 **Result of the measurement: a digital and precise “fingerprint” of the as-is situation, with reliable data for use in a variety of ways.**

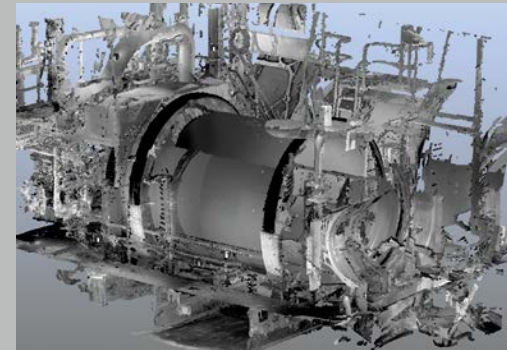

Contour from a point cloud of an industrial installation

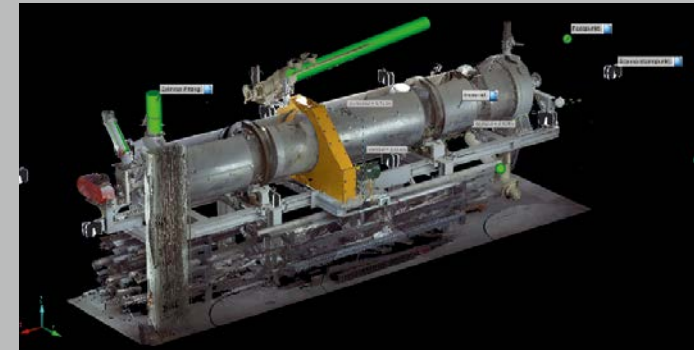

Coloured 3D scan of a drum dryer

## 8 | FOUNDATION MEASUREMENTS

The foundations are the base of your plant, and any damage to them should be detected as early as possible to minimize the risk of failure and downtimes. We use repeated reference measurements to identify foundation settlement or movements.

- » Measurement of the foundations
- » Identification of foundation settlement or movements

 **Definition and calculation of the necessary corrections/measures**



ALL FROM ONE SOURCE

### Original Parts

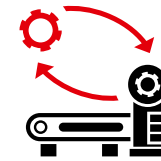

Safeguarding maximum performance, preserving value through long lifespans, reducing downtime:

- » Excellent quality
- » One stop shopping
- » Maximum production reliability
- » Highest availability
- » Optimum customer support
- » Long service life
- » Worldwide delivery

### Excellent Services



Optimizing technology availability, keeping output constant at a high level, strengthening sustainable use:

- » 24/7 hotline
- » Tele remote support
- » Health checks
- » Preventive maintenance
- » Customer training
- » On-site service assignments
- » Flexible service contracts
- » Warranty extension

### Rolling Upgrades



Increasing the output, enhancing productivity of the plant and extending its service life:

- » Process optimization
- » Plant overhauls
- » Hardware and software modifications
- » Technical consulting

### Future Services

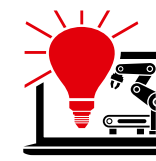

Using the Grenzebach SERICY digitization platform, benefiting from smart and robust processes:

- » AR/VR supported maintenance
- » Predictive maintenance
- » Electronical parts catalogue
- » Online documentation
- » Collaboration app
- » Comprehensive reporting
- » Detailed statistics
- » Advanced analytics



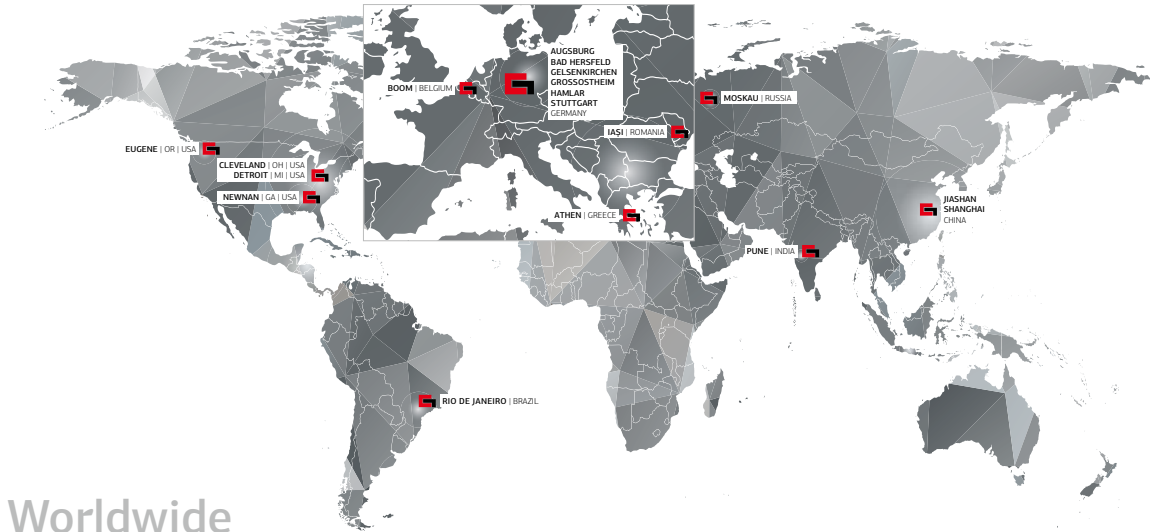

Worldwide

**Grenzebach BSH GmbH**  
Rudolf-Grenzebach-Straße 1  
36251 Bad Hersfeld  
Deutschland  
Hotline: +49 906 982-2400  
E-mail: [service.gbsh@grenzebach.com](mailto:service.gbsh@grenzebach.com)